

Aki and Richards

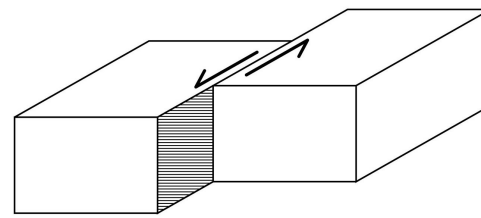

Left-lateral strike-slip fault
($\lambda = 0^\circ$)

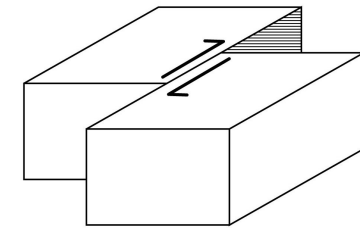

Right-lateral strike-slip fault
($\lambda = 180^\circ$)

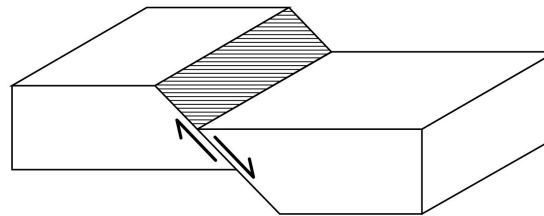

Normal dip-slip fault
($\lambda = -90^\circ$)

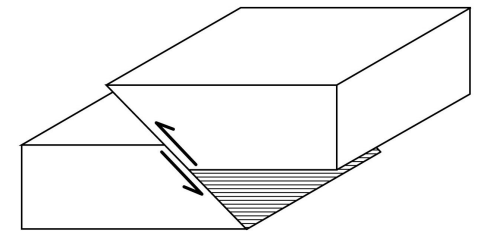

Reverse dip-slip fault
($\lambda = 90^\circ$)

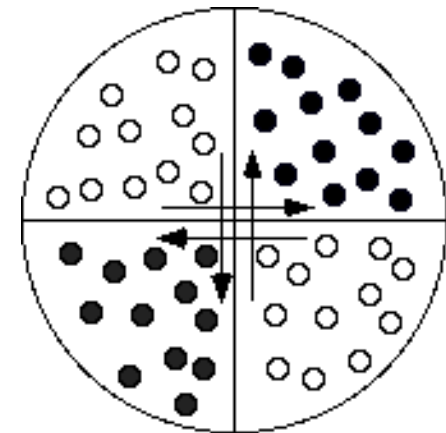
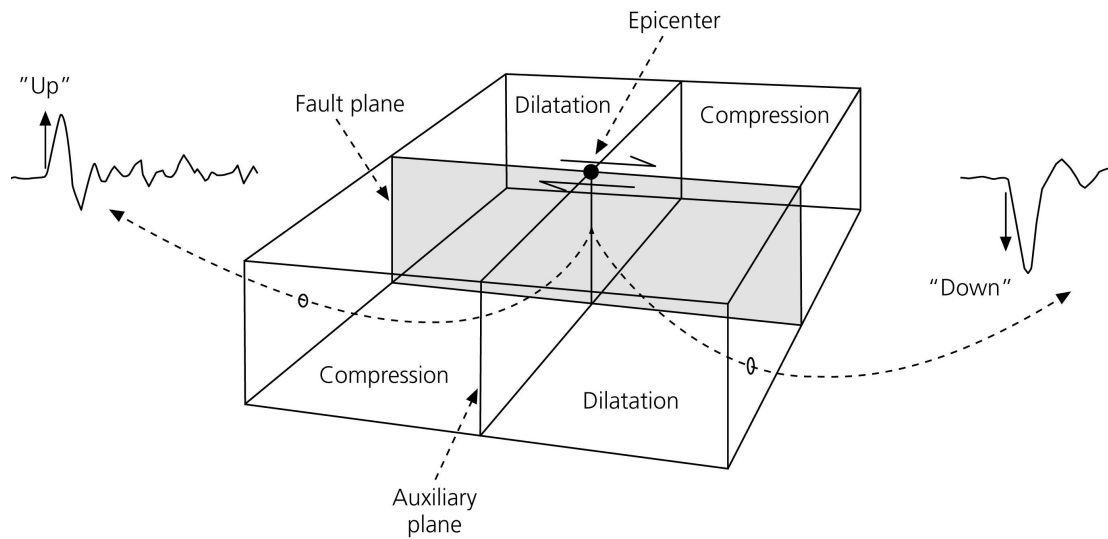

Stein & Wysession, 2003

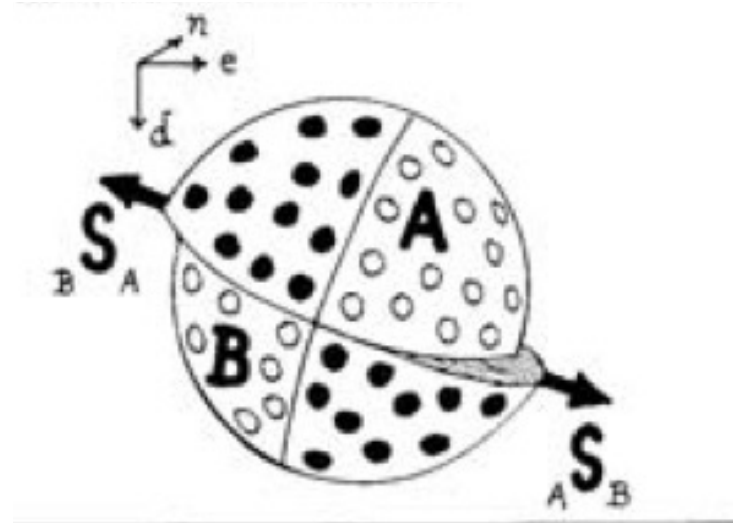
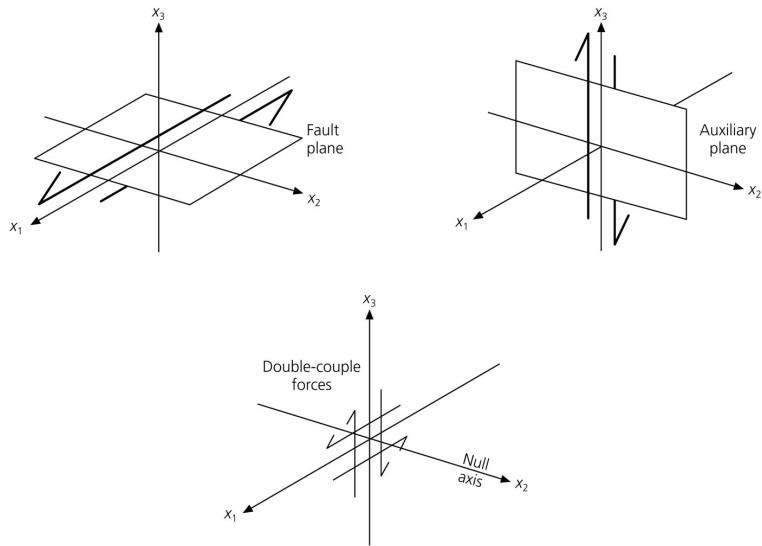

Pearce, 1977

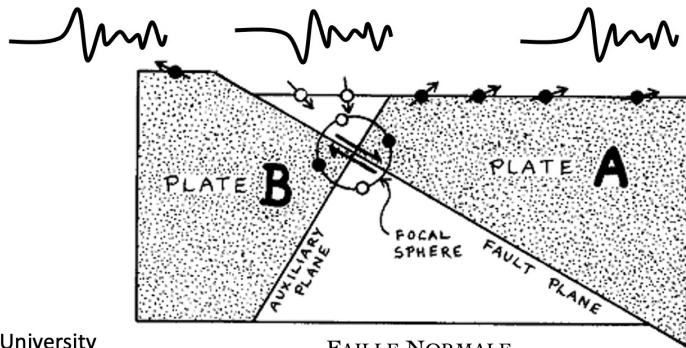
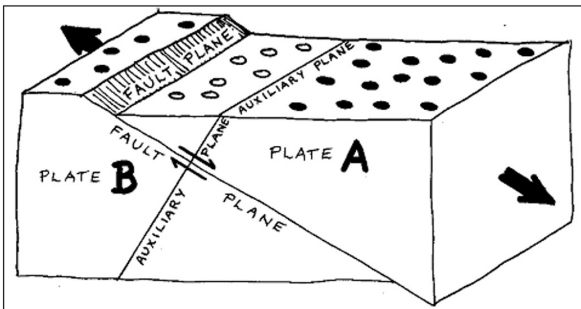

FAILLE NORMALE

courtesy of Ian Hill, University of Cambridge



Schéma 2D du foyer sismique et des quadrants compressifs et extensifs.



USGS, 1996

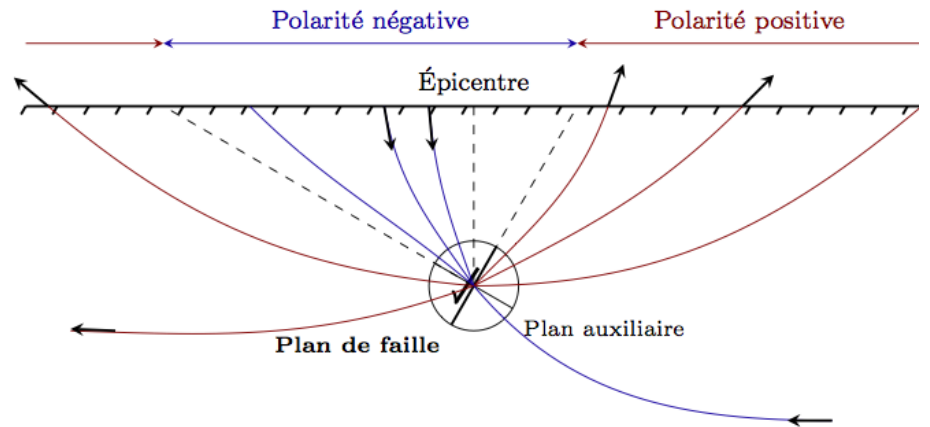
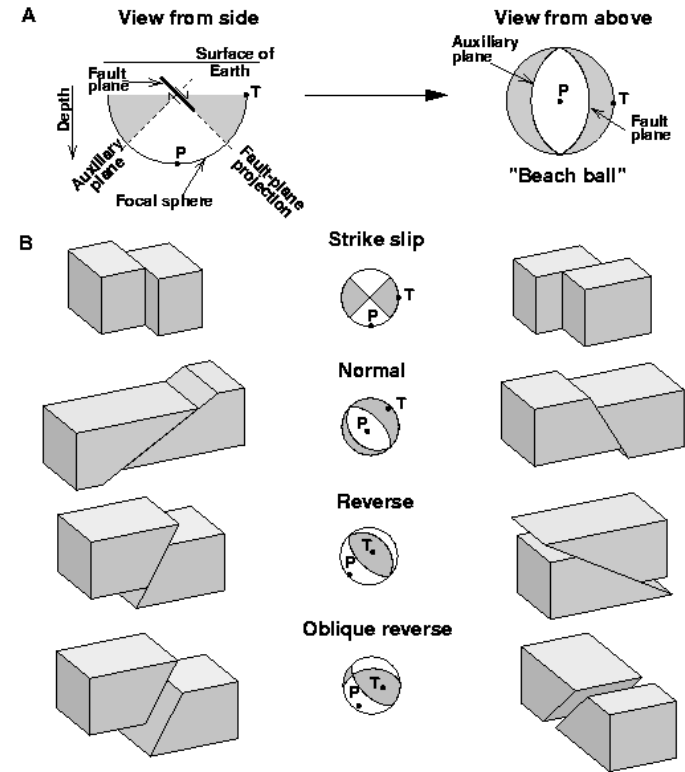
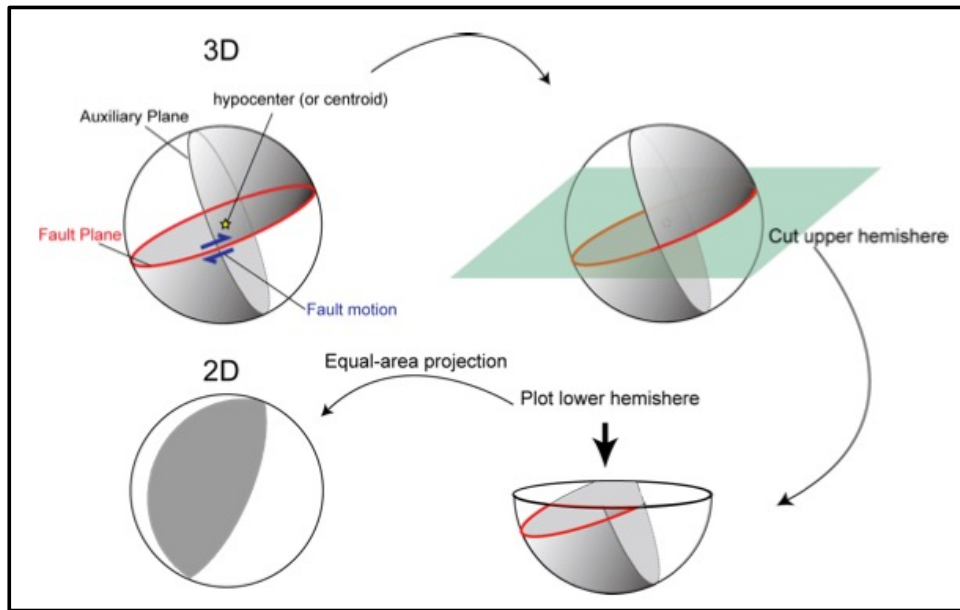